

FOR MORE INFORMATION CALL CLARK TRANSMISSION @ 973.227.4422

FHP and VP SHEAVES

Fractional Horsepower and Variable Pitch Sheaves

BK80

Martin

Martin

SPROCKET & GEAR, INC.

www.martinsprocket.com

VISIT OUR WEB SITE AT WWW.CLARKTR.COM

AK Single Groove FHP Sheaves Bored-To-Size

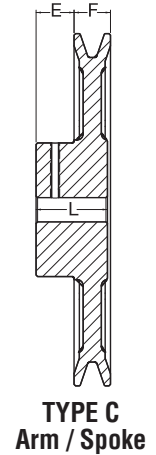
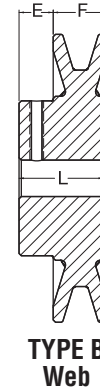

Dimensions in inches

Part Number	Diameter			Type	Stock Finished Bores Includes Keyway and Setscrew	F	E	L Thru Bore	Weight Lbs. (Approx.)
	OD	Datum A(4L) Belts	Pitch 3L Belts						
AK15	1.55	1.30	-	A	1/2 - 5/8	21/32	7/16	13/32	0.3
AK17	1.75	1.50	1.16	A	1/2 - 5/8	21/32	7/16	15/16	0.3
AK19	1.95	1.70	1.36	A	1/2 - 5/8 - 3/4 - 7/8	21/32	7/16	15/16	0.5
AK20	2.00	1.80	1.46	A	1/2 - 5/8 - 3/4 -	21/32	7/16	15/16	0.5
AK21	2.10	1.90	1.56	A	1/2 - 5/8 - 3/4 -	21/32	7/16	15/16	0.5
AK22	2.20	2.00	1.66	A	1/2 - 5/8 - 3/4 - 7/8	21/32	7/16	15/16	0.6
AK23	2.30	2.10	1.76	A	1/2 - 5/8 - 3/4 -	21/32	7/16	15/16	0.6
AK24	2.40	2.20	1.86	A	1/2 - 5/8 - 3/4 - 7/8 - - 1	21/32	7/16	15/16	0.6
AK25	2.50	2.30	1.96	B	1/2 - 5/8 - 3/4 - 7/8 - -	21/32	7/16	15/16	0.7
AK26	2.60	2.40	2.06	B	1/2 - 5/8 - 3/4 - - -	21/32	7/16	15/16	0.7
AK27	2.70	2.50	2.16	B	1/2 - 5/8 - 3/4 - - - 1	21/32	7/16	15/16	0.8
AK28	2.80	2.60	2.26	B	1/2 - 5/8 - 3/4 - 7/8 - -	21/32	7/16	15/16	0.8
AK30	3.05	2.80	2.46	B	1/2 - 5/8 - 3/4 - 7/8 - - 1	21/32	7/16	15/16	0.9
AK32	3.25	3.00	2.66	B	1/2 - 5/8 - 3/4 - 7/8 - - 1	21/32	7/16	15/16	1.0
AK34	3.45	3.20	2.86	B	1/2 - 5/8 - 3/4 - 7/8 - - 1	21/32	7/16	15/16	1.1
AK35	3.55	3.30	2.96	B	1/2 - 5/8 - 3/4 - 7/8 - - 1	21/32	7/16	15/16	1.2
AK39	3.75	3.50	3.16	B	1/2 - 5/8 - 3/4 - 7/8 - 15/16 - 1	3/4	15/32	15/32	1.6
AK41	3.95	3.70	3.36	B	1/2 - 5/8 - 3/4 - 7/8 - 15/16 - 1 - 1 1/8	3/4	15/32	15/32	1.6
AK44	4.25	4.00	3.66	B	1/2 - 5/8 - 3/4 - 7/8 - 15/16 - 1 - 1 1/8	3/4	15/32	15/32	1.9
AK46	4.45	4.20	3.86	B	1/2 - 5/8 - 3/4 - 7/8 - 15/16 - 1 - 1 1/8	3/4	15/32	15/32	2.0
AK49	4.75	4.50	4.16	B	1/2 - 5/8 - 3/4 - 7/8 - 15/16 - 1 - 1 1/8	3/4	15/32	15/32	2.1
AK51	4.95	4.70	4.36	B	1/2 - 5/8 - 3/4 - 7/8 - 15/16 - 1 - 1 1/8	3/4	15/32	15/32	2.2
AK54	5.25	5.00	4.66	B	1/2 - 5/8 - 3/4 - 7/8 - 15/16 - 1 - 1 1/8 - 1 1/16	3/4	15/32	15/32	2.4
AK56	5.45	5.20	4.86	B	1/2 - 5/8 - 3/4 - 7/8 - 15/16 - 1 - 1 1/8 - 1 1/16	3/4	15/32	15/32	2.5
AK59	5.75	5.50	5.16	C	1/2 - 5/8 - 3/4 - 7/8 - 15/16 - 1 - 1 1/8 - 1 1/16	3/4	15/32	15/32	2.7
AK61	5.95	5.70	5.36	C	1/2 - 5/8 - 3/4 - 7/8 - 15/16 - 1 - 1 1/8 - 1 1/16	3/4	15/32	15/32	2.8
AK64	6.25	6.00	5.66	C	1/2 - 5/8 - 3/4 - 7/8 - 15/16 - 1 - 1 1/8 - 1 1/16	3/4	15/32	15/32	3.0
AK66	6.45	6.20	5.86	C	- 5/8 - 3/4 - - - - 1 - 1 1/8 -	3/4	15/32	15/32	3.0
AK69	6.75	6.50	6.16	C	- - 3/4 - - - - - 1 - 1 1/8 -	3/4	15/32	15/32	3.7
AK71	6.95	6.70	6.36	C	1/2 - 5/8 - 3/4 - - - - 1 - 1 1/8 - - - 1 1/16	3/4	23/32	115/32	4.3
AK74	7.25	7.00	6.66	C	1/2 - 5/8 - 3/4 - - - 15/16 - 1 - 1 1/8 - 1 1/16 - 1 1/4 - - - 1 1/16	3/4	23/32 *	115/32	4.5
AK79	7.75	7.50	7.16	C	- - - 3/4 - - - - 1 - 1 1/8 - - - - 1 1/16	3/4	23/32	115/32	4.7
AK81	7.95	7.70	7.36	C	- - 5/8 - 3/4 - - - - 1 - - - 1 1/16 - - -	3/4	23/32	115/32	4.7
AK84	8.25	8.00	7.66	C	1/2 - 5/8 - 3/4 - - - 15/16 - 1 - - - 1 1/16 - - - - 1 1/16	3/4	23/32 *	115/32	5.0
AK89	8.75	8.50	8.16	C	- - - 3/4 - - - - 1 - 1 1/8 - - - - 1 1/16	3/4	23/32	115/32	5.2
AK91	8.95	8.70	8.36	C	- - - 3/4 - - - - 1 - - - - - - - - -	3/4	23/32	115/32	5.2
AK94	9.25	9.00	8.66	C	1/2 - 5/8 - 3/4 - - - 15/16 - 1 - - - 1 1/16 - 1 1/4 - - - 1 1/16	3/4	23/32 *	115/32	5.5
AK99	9.75	9.50	9.16	C	- - - 3/4 - - - - 1 - - - - - - - - - 1 1/16	3/4	23/32 *	115/32	5.7
AK104	10.25	10.00	9.66	C	- 5/8 - 3/4 - - - - 1 - - - 1 1/16 - 1 1/4 - 1 3/8 - 1 1/16	3/4	23/32	115/32	5.9
AK109	10.75	10.50	10.16	C	- - 3/4 - - - - 1 - - - - 1 1/8 - 1 1/16	3/4	23/32	115/32	6.1
AK114	11.25	11.00	10.66	C	- - 3/4 - - - - 1 - - - 1 1/16 - - - - 1 1/16	3/4	23/32 *	115/32	6.7
AK124	12.25	12.00	11.66	C	- 5/8 - 3/4 - - - - 1 - - - 1 1/16 - 1 1/4 - - - 1 1/16	3/4	23/32 *	115/32	7.3
AK134	13.25	13.00	12.66	C	- - 3/4 - - - - 1 - - - 1 1/16 - - - 1 3/8 - 1 1/16	3/4	23/32	115/32	8.2
AK144	14.25	14.00	13.66	C	- - 3/4 - - - - 1 - - - 1 1/16 - - - - 1 1/16	3/4	23/32	115/32	8.7
AK154	15.25	15.00	14.66	C	- 3/4 - - - - 1 - - - - - - - - - 1 1/16	3/4	23/32	115/32	9.7
AK184	18.25	18.00	17.66	C	- 3/4 - - - - 1 - - - 1 1/16 - - - - 1 1/16	3/4	23/32	115/32	11.8

* E = 25/32 FOR BORE SIZES <= 1
1/2" Bore - setscrew only - no keyway



Two Groove FHP Sheaves Bored-To-Size **2AK**

Keyway Dimensions Inch Bore

Diameter Of Shaft	Keyway Width X Depth
1/2	NONE
5/8 - 7/8	3/16 X 3/32
15/16 - 1-1/4	1/4 X 1/8
1-5/16 - 1-3/8	5/16 X 5/32
1-7/16 - 1-3/4	3/8 X 3/16



TYPE A
Solid

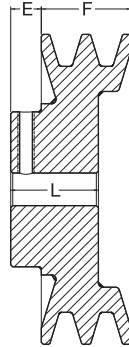

TYPE B
Web

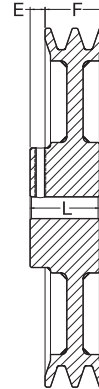

TYPE C
Arm / Spoke



Dimensions in inches

Part Number	Diameter			Type	Stock Finished Bores Includes Keyway and Setscrew	F	E	L Thru Bore	Weight Lbs. (Approx.)
	OD	Datum A(4L) Belts	Pitch 3L Belts						
2AK20	2.00	1.80	1.46	A	1/2 - 5/8 - 3/4	1 3/8	1 5/32	1 21/32	0.8
2AK21	2.15	1.90	1.56	A	1/2 - 5/8 - 3/4	1 3/8	1 5/32	1 21/32	0.9
2AK22	2.25	2.00	1.66	A	1/2 - 5/8 - 3/4 - 7/8 - - 1	1 3/8	1 5/32	1 21/32	1.1
2AK23	2.35	2.10	1.76	A	- 5/8 - 3/4 - 7/8 - - 1	1 3/8	1 5/32	1 21/32	1.2
2AK25	2.55	2.30	1.96	A	- 5/8 - 3/4 - 7/8 - - 1	1 3/8	1 5/32	1 21/32	1.4
2AK26	2.65	2.40	2.06	A	- 5/8 - 3/4 - 7/8 - -	1 3/8	1 5/32	1 21/32	1.5
2AK27	2.75	2.50	2.16	A	- 5/8 - 3/4 - 7/8 - - 1	1 3/8	1 5/32	1 21/32	1.6
2AK28	2.85	2.60	2.26	A	- 5/8 - 3/4 - 7/8 - - 1	1 3/8	1 5/32	1 21/32	1.7
2AK30	3.05	2.80	2.46	A	1/2 - 5/8 - 3/4 - 7/8 - - 1 - 1 1/8	1 3/8	1 5/32	1 21/32	2.0
2AK32	3.25	3.00	2.66	A	5/8 - 3/4 - 7/8 - - 1 - 1 1/8	1 3/8	1 5/32	1 21/32	2.2
2AK34	3.45	3.20	2.86	A	5/8 - 3/4 - 7/8 - - 1 - 1 1/8	1 3/8	1 5/32	1 21/32	2.5
2AK39	3.75	3.50	3.16	B	5/8 - 3/4 - 7/8 - - 1 - 1 1/8	1 3/8	1 5/32	1 11/32	2.6
2AK41	3.95	3.70	3.36	B	5/8 - 3/4 - 7/8 - - 1 - 1 1/8	1 3/8	1 5/32	1 11/32	2.9
2AK44	4.25	4.00	3.66	B	5/8 - 3/4 - 7/8 - - 1 - 1 1/8	1 3/8	1 5/32	1 11/32	3.3
2AK46	4.45	4.20	3.86	B	5/8 - - 7/8 - - 1 - 1 1/8	1 3/8	1 5/32	1 11/32	3.6
2AK49	4.75	4.50	4.16	B	- 3/4 - 7/8 - - 1 - 1 1/8 - - 1 3/8	1 3/8	1 5/32	1 11/32	4.1
2AK51	4.95	4.70	4.36	B	- 3/4 - 7/8 - - 1 - 1 1/8 - - 1 3/8	1 3/8	1 5/32	1 11/32	4.5
2AK54	5.25	5.00	4.66	B	5/8 - 3/4 - 7/8 - - 1 - 1 1/8 - - 1 3/8	1 3/8	1 5/32	1 11/32	4.1
2AK56	5.45	5.20	4.86	B	5/8 - 3/4 - - - 1 - 1 1/8 - - 1 3/8	1 3/8	1 5/32	1 11/32	4.1
2AK59	5.75	5.50	5.16	B	- - - - 1 - 1 1/8 - - 1 3/8	1 3/8	1 5/32	1 11/32	4.3
2AK61	5.95	5.70	5.36	B	3/4 - 7/8 - - 1 - 1 1/8 - - 1 3/8	1 3/8	1 5/32	1 11/32	4.5
2AK64	6.25	6.00	5.66	C	3/4 - - - 1 - 1 1/8 - 1 3/16 - 1 3/8 - 1 7/16	1 3/8	1 11/32	1 19/32	5.6
2AK74	7.25	7.00	6.66	C	3/4 - - - 1 - 1 1/8 - 1 3/16 - 1 3/8 - 1 7/16	1 3/8	1 11/32	1 19/32	6.5
2AK84	8.25	8.00	7.66	C	3/4 - - - 1 5/16 - 1 - 1 1/8 - - 1 3/8 - 1 7/16	1 3/8	1 11/32	1 19/32	7.2
2AK94	9.25	9.00	8.66	C	3/4 - 7/8 - - 1 - 1 1/8 - 1 3/16 - 1 3/8 - 1 7/16	1 3/8	1 11/32	1 19/32	8.0
2AK104	10.25	10.00	9.66	C	3/4 - - - 1 5/16 - 1 - - 1 3/16 - - 1 7/16	1 3/8	1 11/32	1 19/32	9.0
2AK114	11.25	11.00	10.66	C	1 - - - 1 3/16 - 1 3/8 - 1 7/16	1 3/8	1 11/32	1 19/32	9.7
2AK124	12.25	12.00	11.66	C	1 - - - 1 3/16 - - 1 7/16	1 3/8	1 11/32	1 19/32	10.5
2AK134	13.25	13.00	12.66	C	- - - 1 3/16 - - 1 7/16	1 3/8	1 11/32	1 19/32	12.7
2AK144	14.25	14.00	13.66	C	1 - - - 1 3/16 - - 1 7/16	1 3/8	1 11/32	1 19/32	13.1
2AK154	15.25	15.00	14.66	C	1 3/16 - - - 1 7/16	1 3/8	1 11/32	1 19/32	14.3
2AK184	18.25	18.00	17.66	C	1 3/16 - - - 1 7/16	1 3/8	1 11/32	1 19/32	17.1

1/2" Bore - setscrew only - no keyway

AK-H Single Groove FHP Sheaves

MST® Bushed



TYPE A
Solid

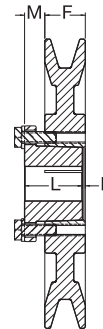

TYPE B
Web

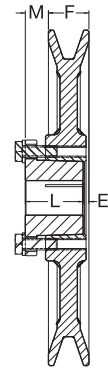

TYPE C
Arm / Spoke

Dimensions in inches, weight in pounds

Part Number	Diameter			Type	Bush	Bush Max. Bore	F	E	L Thru Bore	M	Weight Less Bush
	OD	Datum A(4L) Belts	Pitch 3L Belts								
AK30-H	3.05	2.80	2.46	A	H	1-1/2	3/4	3/8	1-1/4	7/8	1.3
AK32-H	3.25	3.00	2.66	A	H	1-1/2	3/4	3/8	1-1/4	7/8	1.4
AK34-H	3.45	3.20	2.86	A	H	1-1/2	3/4	1/16	1-1/4	9/16	1.2
AK39-H	3.75	3.50	3.16	A	H	1-1/2	3/4	1/16	1-1/4	9/16	1.4
AK41-H	3.95	3.70	3.36	A	H	1-1/2	3/4	1/16	1-1/4	9/16	1.6
AK44-H	4.25	4.00	3.66	A	H	1-1/2	3/4	1/16	1-1/4	9/16	2.0
AK46-H	4.45	4.20	3.86	A	H	1-1/2	3/4	1/16	1-1/4	9/16	2.2
AK49-H	4.75	4.50	4.16	B	H	1-1/2	3/4	1/16	1-1/4	9/16	2.1
AK51-H	4.95	4.70	4.36	B	H	1-1/2	3/4	1/16	1-1/4	9/16	2.3
AK54-H	5.25	5.00	4.66	B	H	1-1/2	3/4	1/16	1-1/4	9/16	2.3
AK56-H	5.45	5.20	4.86	B	H	1-1/2	3/4	1/16	1-1/4	9/16	2.4
AK59-H	5.75	5.50	5.16	B	H	1-1/2	3/4	1/16	1-1/4	9/16	2.5
AK61-H	5.95	5.70	5.36	C	H	1-1/2	3/4	1/16	1-1/4	9/16	2.6
AK64-H	6.25	6.00	5.66	C	H	1-1/2	3/4	1/16	1-1/4	9/16	2.8
AK66-H	6.45	6.20	5.86	C	H	1-1/2	3/4	1/16	1-1/4	9/16	2.8
AK69-H	6.75	6.50	6.16	C	H	1-1/2	3/4	1/16	1-1/4	9/16	3.0
AK71-H	6.95	6.70	6.36	C	H	1-1/2	3/4	1/16	1-1/4	9/16	3.0
AK74-H	7.25	7.00	6.66	C	H	1-1/2	3/4	1/16	1-1/4	9/16	3.3
AK79-H	7.75	7.50	7.16	C	H	1-1/2	3/4	1/16	1-1/4	9/16	3.5
AK84-H	8.25	8.00	7.66	C	H	1-1/2	3/4	1/16	1-1/4	9/16	3.8
AK89-H	8.75	8.50	8.16	C	H	1-1/2	3/4	1/16	1-1/4	9/16	4.0
AK94-H	9.25	9.00	8.66	C	H	1-1/2	3/4	1/16	1-1/4	9/16	4.4
AK99-H	9.75	9.50	9.16	C	H	1-1/2	3/4	1/16	1-1/4	9/16	4.7
AK104-H	10.25	10.00	9.66	C	H	1-1/2	3/4	1/16	1-1/4	9/16	5.0
AK109-H	10.75	10.50	10.16	C	H	1-1/2	3/4	1/16	1-1/4	9/16	5.2
AK114-H	11.25	11.00	10.66	C	H	1-1/2	3/4	1/16	1-1/4	9/16	5.5
AK124-H	12.25	12.00	11.66	C	H	1-1/2	3/4	1/16	1-1/4	9/16	6.0
AK134-H	13.25	13.00	12.66	C	H	1-1/2	3/4	1/16	1-1/4	9/16	7.3
AK144-H	14.25	14.00	13.66	C	H	1-1/2	3/4	1/16	1-1/4	9/16	7.9
AK154-H	15.25	15.00	14.66	C	H	1-1/2	3/4	1/16	1-1/4	9/16	8.9
AK184-H	18.25	18.00	17.66	C	H	1-1/2	3/4	1/16	1-1/4	9/16	11.4

Weights do not include bushings.



Two Groove FHP Sheaves MST® Bushed 2AK-H

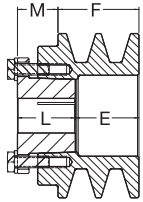

TYPE A
Solid

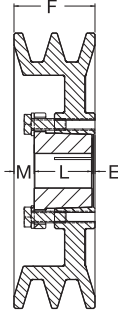

TYPE B
Web

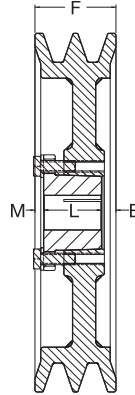

TYPE C
Arm / Spoke



Dimensions in inches, weight in pounds

Part Number	Diameter			Type	Bush	Bush Max. Bore	F	E	L Thru Bore	M	Weight Less Bush
	OD	Datum A(4L) Belts	Pitch 3L Belts								
2AK30-H	3.05	2.80	2.46	A	H	1-1/2	1-3/8	1	1-1/4	7/8	1.7
2AK32-H	3.25	3.00	2.66	A	H	1-1/2	1-3/8	1	1-1/4	7/8	1.9
2AK34-H	3.45	3.20	2.86	A	H	1-1/2	1-3/8	9/16	1-1/4	7/16	1.7
2AK39-H	3.75	3.50	3.16	A	H	1-1/2	1-3/8	9/16	1-1/4	7/16	2.0
2AK41-H	3.95	3.70	3.36	B	H	1-1/2	1-3/8	1/16	1-1/4	1/16	2.2
2AK44-H	4.25	4.00	3.66	B	H	1-1/2	1-3/8	1/16	1-1/4	1/16	2.7
2AK46-H	4.45	4.20	3.86	B	H	1-1/2	1-3/8	1/16	1-1/4	1/16	3.0
2AK49-H	4.75	4.50	4.16	B	H	1-1/2	1-3/8	1/16	1-1/4	1/16	3.1
2AK51-H	4.95	4.70	4.36	B	H	1-1/2	1-3/8	1/16	1-1/4	1/16	3.5
2AK54-H	5.25	5.00	4.66	B	H	1-1/2	1-3/8	1/16	1-1/4	1/16	3.4
2AK56-H	5.45	5.20	4.86	B	H	1-1/2	1-3/8	1/16	1-1/4	1/16	3.6
2AK59-H	5.75	5.50	5.16	C	H	1-1/2	1-3/8	1/16	1-1/4	1/16	3.4
2AK61-H	5.95	5.70	5.36	C	H	1-1/2	1-3/8	1/16	1-1/4	1/16	3.7
2AK64-H	6.25	6.00	5.66	C	H	1-1/2	1-3/8	1/16	1-1/4	1/16	3.9
2AK74-H	7.25	7.00	6.66	C	H	1-1/2	1-3/8	1/16	1-1/4	1/16	5.0
2AK84-H	8.25	8.00	7.66	C	H	1-1/2	1-3/8	1/16	1-1/4	1/16	5.6
2AK94-H	9.25	9.00	8.66	C	H	1-1/2	1-3/8	1/16	1-1/4	1/16	6.3
2AK104-H	10.25	10.00	9.66	C	H	1-1/2	1-3/8	1/16	1-1/4	1/16	7.6
2AK114-H	11.25	11.00	10.66	C	H	1-1/2	1-3/8	1/16	1-1/4	1/16	8.4
2AK124-H	12.25	12.00	11.66	C	H	1-1/2	1-3/8	1/16	1-1/4	1/16	9.2
2AK134-H	13.25	13.00	12.66	C	H	1-1/2	1-3/8	1/16	1-1/4	1/16	11.5
2AK144-H	14.25	14.00	13.66	C	H	1-1/2	1-3/8	1/16	1-1/4	1/16	11.8
2AK154-H	15.25	15.00	14.66	C	H	1-1/2	1-3/8	1/16	1-1/4	1/16	13.3
2AK184-H	18.25	18.00	17.66	C	H	1-1/2	1-3/8	1/16	1-1/4	1/16	16.9

Weights do not include bushings.

MST "H" Bushings – Inch Bore

Diameter Of Shaft	Keyway Width X Depth	Diameter Of Shaft	Keyway Width X Depth
3/8	NONE	1	1/4 X 1/8
7/16	NONE	1-1/16	1/4 X 1/8
1/2	1/8 X 1/16	1-1/8	1/4 X 1/8
9/16	1/8 X 1/16	1-3/16	1/4 X 1/8
19/32	1/8 X 1/16	1-1/4	1/4 X 1/8
5/8	3/16 X 3/32	1-5/16	5/16 X 1/16
21/32	3/16 X 3/32	1-3/8	5/16 X 1/16
11/16	3/16 X 3/32	1-3/8W	3/8 X 1/16
3/4	3/16 X 3/32	1-7/16	3/8 X 1/16
25/32	3/16 X 3/32	1-1/2	3/8 X 1/32
13/16	3/16 X 3/32		
7/8	3/16 X 3/32		
15/16	1/4 X 1/8		
31/32	1/4 X 1/8		

MST "H" Bushings – Millimeter Bore

Diameter Of Shaft	Keyway Width X Depth	Diameter Of Shaft	Keyway Width X Depth
10	NONE	22	6 X 2.8
11	NONE	24	8 X 3.3
12	NONE	25	8 X 3.3
14	5 X 2.3	28	8 X 3.3
16	5 X 2.3	30	8 X 3.3
18	6 X 2.8	32	10 X 1.3
19	6 X 2.8	35	10 X 0.3
20	6 X 2.8	36	10 X 1.3
		38	10 X 0.3

BK Single Groove FHP Sheaves Bored-To-Size

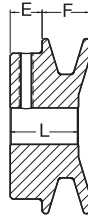

TYPE A
Solid

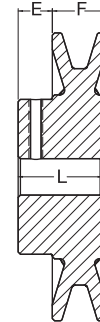

TYPE B
Web



TYPE C
Arm / Spoke

Dimensions in inches

Part Number	Diameter			Type	Stock Finished Bores Includes Keyway and Setscrew	F	E	L Thru Bore	Weight Lbs. (Approx.)
	OD	Datum A(4L) Belts	Datum B(5L) Belts						
BK23	2.30	-	2.10	A	5/8 - - - - 1	13/16	13/32	1 1/16	0.4
BK24	2.40	1.80	2.20	A	1/2 - 5/8 - 3/4 - 7/8 - -	13/16	13/32	1 1/16	0.4
BK25	2.50	1.90	2.30	A	1/2 - 5/8 - 3/4 - 7/8 - -	13/16	13/32	1 1/16	0.5
BK26	2.60	2.00	2.40	A	1/2 - 5/8 - 3/4 - 7/8 - -	13/16	13/32	1 1/16	0.6
BK27	2.70	2.10	2.50	B	1/2 - 5/8 - 3/4 - 7/8 - - 1 1/8	13/16	13/32	1 1/16	0.6
BK28	2.95	2.20	2.60	B	1/2 - 5/8 - 3/4 - 7/8 - - 1 - 1 1/8	13/16	13/32	1 1/16	0.8
BK30	3.15	2.40	2.80	B	1/2 - 5/8 - 3/4 - 7/8 - - 1 - 1 1/8	13/16	13/32	1 1/16	0.8
BK32	3.35	2.60	3.00	B	1/2 - 5/8 - 3/4 - 7/8 - - 1 -	13/16	13/32	1 1/16	0.8
BK34	3.55	2.80	3.20	B	1/2 - 5/8 - 3/4 - 7/8 - - 1 - 1 1/8	7/8	13/32	1 5/32	1.3
BK36	3.75	3.00	3.40	B	1/2 - 5/8 - 3/4 - 7/8 - - 1 - 1 1/8	7/8	13/32	1 5/32	1.5
BK40	3.95	3.20	3.60	B	1/2 - 5/8 - 3/4 - 7/8 - - 1 - 1 1/8	7/8	13/32	1 5/32	1.5
BK45	4.25	3.50	3.90	B	1/2 - 5/8 - 3/4 - 7/8 - - 1 - 1 1/8	7/8	13/32	1 5/32	1.8
BK46	4.35	3.60	4.00	B	- - - - 7/8 - - -	7/8	13/32	1 5/32	1.8
BK47	4.45	3.70	4.10	B	1/2 - 5/8 - 3/4 - 7/8 - - 1 - 1 1/8	7/8	13/32	1 5/32	1.8
BK48	4.55	3.80	4.20	B	1/2 - 5/8 - 3/4 - 7/8 - - - 1 1/8	7/8	13/32	1 5/32	2.0
BK50	4.75	4.00	4.40	B	1/2 - 5/8 - 3/4 - 7/8 - 1 5/16 - 1 - 1 1/8	7/8	13/32	1 5/32	2.0
BK52	4.95	4.20	4.60	B	1/2 - 5/8 - 3/4 - 7/8 - - 1 - 1 1/8	7/8	13/32	1 5/32	2.0
BK55	5.25	4.50	4.90	B	1/2 - 5/8 - 3/4 - 7/8 - - 1 - 1 1/8 - 1 3/16	7/8	13/32	1 5/32	2.2
BK57	5.45	4.70	5.10	B	- 5/8 - 3/4 - 7/8 - 1 5/16 - 1 - 1 1/8 -	7/8	13/32	1 5/32	2.3
BK60	5.75	5.00	5.40	B	1/2 - 5/8 - 3/4 - 7/8 - - 1 - 1 1/8 - 1 3/16	7/8	13/32	1 5/32	2.3
BK62	5.95	5.20	5.60	B	1/2 - 5/8 - 3/4 - 7/8 - 1 5/16 - 1 - 1 1/8 - 1 3/16	7/8	13/32	1 5/32	2.4
BK65	6.25	5.50	5.90	B	5/8 - 3/4 - 7/8 - - 1 - 1 1/8 -	7/8	13/32	1 5/32	2.7
BK67	6.45	5.70	6.10	C	5/8 - 3/4 - 7/8 - - 1 - 1 1/8 -	7/8	13/32	1 5/32	2.8
BK70	6.75	6.00	6.40	C	5/8 - 3/4 - 7/8 - 1 5/16 - 1 - 1 1/8 - 1 3/16 - - - 1 7/16	7/8	2 1/32 *	1 15/32	3.3
BK72	6.95	6.20	6.60	C	- 3/4 - - - 1 - 1 1/8 - - - 1 3/8 - 1 7/16	7/8	2 1/32	1 15/32	3.9
BK75	7.25	6.50	6.90	C	- 3/4 - - - 1 - 1 1/8 - - - - 1 7/16	7/8	2 1/32	1 15/32	3.9
BK77	7.45	6.70	7.10	C	- 3/4 - - - 1 - 1 1/8 - - - - 1 3/8 - 1 7/16	7/8	2 1/32	1 15/32	4.1
BK80	7.75	7.00	7.40	C	5/8 - 3/4 - 7/8 - - 1 - 1 1/8 - 1 3/16 - 1 1/4 - 1 3/8 - 1 7/16	7/8	2 1/32	1 15/32	4.4
BK85	8.25	7.50	7.90	C	3/4 - - - 1 - 1 1/8 - 1 3/16 - - - 1 3/8 - 1 7/16	7/8	2 1/32	1 15/32	5.0
BK90	8.75	8.00	8.40	C	3/4 - 7/8 - 1 5/16 - 1 - 1 1/8 - 1 3/16 - - - 1 3/8 - 1 7/16	7/8	2 1/32	1 15/32	5.0
BK95	9.25	8.50	8.90	C	3/4 - - - 1 - 1 1/8 - - - - 1 3/8 - 1 7/16	7/8	2 1/32	1 15/32	5.4
BK100	9.75	9.00	9.40	C	3/4 - 7/8 - - 1 - 1 1/8 - 1 3/16 - 1 1/4 - 1 3/8 - 1 7/16	7/8	2 1/32	1 15/32	5.6
BK105	10.25	9.50	9.90	C	- - - 1 - - - - - 1 3/8 - 1 7/16	7/8	2 1/32	1 15/32	5.8
BK110	10.75	10.00	10.40	C	3/4 - - - 1 - 1 1/8 - 1 3/16 - - - 1 3/8 - 1 7/16	7/8	2 1/32	1 15/32	6.4
BK115	11.25	10.50	10.90	C	- - - 1 - - - - - 1 3/8 - 1 7/16	7/8	2 1/32	1 15/32	6.9
BK120	11.75	11.00	11.40	C	3/4 - - - 1 - - - 1 3/16 - - - 1 3/8 - 1 7/16	7/8	2 1/32	1 15/32	7.4
BK130	12.75	12.00	12.40	C	3/4 - 7/8 - - 1 - 1 - 1 1/8 - 1 3/16 - - - 1 7/16	7/8	2 1/32	1 15/32	8.4
BK140	13.75	13.00	13.40	C	3/4 - - - 1 - - - 1 3/16 - - - 1 7/16	7/8	2 1/32	1 15/32	9.4
BK160	15.75	15.00	15.40	C	1 - 1 1/8 - 1 3/16 - 1 1/4 - - 1 7/16	7/8	2 1/32	1 15/32	11.4
BK190	18.75	18.00	18.40	C	1 - - - 1 3/16 - 1 1/4 - - 1 7/16	7/8	2 1/32	1 15/32	13.4

* E = 13/32 FOR BORE SIZES <= 1
1/2" Bore - setscrew only - no keyway



Two Groove FHP Sheaves Bored-To-Size **2BK**

Keyway Dimensions Inch Bore

Diameter Of Shaft	Keyway Width X Depth
1/2	NONE
5/8 - 7/8	3/16 X 3/32
15/16 - 1-1/4	1/4 X 1/8
1-5/16 - 1-3/8	5/16 X 5/32
1-7/16 - 1-3/4	3/8 X 3/16

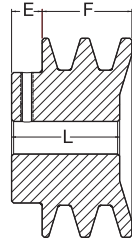

TYPE A
Solid

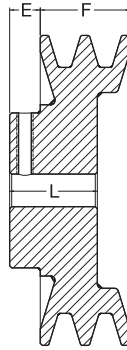

TYPE B
Web

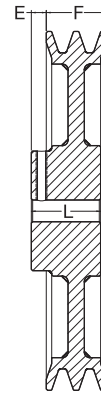

TYPE C
Arm / Spoke



Dimensions in inches

Part Number	Diameter			Type	Stock Finished Bores Includes Keyway and Setscrew	F	E	L Thru Bore	Weight Lbs. (Approx.)
	OD	Datum A(4L) Belts	Datum B(5L) Belts						
2BK25	2.50	1.90	2.30	A	1/2 - 5/8 - 3/4 - 7/8 - 1 - 1 1/8	1 3/4	1 5/32	1 31/32	1.3
2BK26	2.60	2.00	2.40	A	1/2 - 5/8 - 3/4 - 7/8 - 1 - 1 1/8	1 3/4	1 5/32	1 31/32	1.5
2BK27	2.70	2.10	2.50	A	1/2 - 5/8 - 3/4 - 7/8 - 1 - 1 1/8	1 3/4	1 5/32	1 31/32	1.6
2BK28	2.95	2.20	2.60	A	1/2 - 5/8 - 3/4 - 7/8 - 1 - 1 1/8	1 3/4	1 5/32	1 31/32	1.9
2BK30	3.15	2.40	2.80	A	1/2 - 5/8 - 3/4 - 7/8 - 1 - 1 1/8	1 3/4	1 5/32	1 31/32	2.3
2BK32	3.35	2.60	3.00	A	5/8 - 3/4 - 7/8 - 1 - 1 1/8	1 3/4	1 5/32	1 31/32	2.6
2BK34	3.55	2.80	3.20	A	5/8 - 3/4 - 7/8 - 1 - 1 1/8	1 3/4	1 5/32	1 31/32	2.8
2BK36	3.75	3.00	3.40	A	5/8 - 3/4 - 7/8 - 1 - 1 1/8 - 1 3/8	1 3/4	1 5/32	1 31/32	3.3
2BK40	3.95	3.20	3.60	B	5/8 - 3/4 - 7/8 - 1 - 1 1/8 - 1 3/8	1 3/4	1 5/32	1 15/32	3.3
2BK45	4.25	3.50	3.90	B	5/8 - 3/4 - 7/8 - 1 - 1 1/8 - 1 3/8	1 3/4	1 5/32	1 15/32	3.3
2BK47	4.45	3.70	4.10	B	3/4 - 7/8 - 1 - 1 1/8 - 1 3/8	1 3/4	1 5/32	1 15/32	3.7
2BK50	4.75	4.00	4.40	B	3/4 - 7/8 - 1 - 1 1/8 - 1 3/8	1 3/4	1 5/32	1 15/32	4.1
2BK52	4.95	4.20	4.60	B	3/4 - 7/8 - 1 - 1 1/8 - 1 3/8	1 3/4	1 5/32	1 15/32	4.5
2BK55	5.25	4.50	4.90	B	3/4 - 7/8 - 1 - 1 1/8 - 1 3/8	1 3/4	1 5/32	1 15/32	4.5
2BK57	5.45	4.70	5.10	B	3/4 - 7/8 - 1 - 1 1/8 - 1 3/8	1 3/4	1 5/32	1 15/32	5.1
2BK60	5.75	5.00	5.40	B	3/4 - 7/8 - 1 - 1 1/8 - 1 3/8	1 3/4	1 5/32	1 15/32	4.9
2BK62	5.95	5.20	5.60	B	3/4 - 7/8 - 1 - 1 1/8 - 1 3/8	1 3/4	1 5/32	1 15/32	4.8
2BK65	6.25	5.50	5.90	B	3/4 - 7/8 - 1 - 1 1/8 - 1 3/8	1 3/4	1 5/32	1 15/32	5.0
2BK67	6.45	5.70	6.10	C	3/4 - 7/8 - 1 - 1 1/8 - 1 3/8	1 3/4	1 5/32	1 15/32	5.0
2BK70	6.75	6.00	6.40	C	3/4 - 7/8 - 1 - 1 1/8 - 1 3/8 - 1 1/16 - 1 1/16	1 3/4	1 11/32	1 19/32	6.6
2BK80	7.75	7.00	7.40	C	3/4 - 7/8 - 1 - 1 1/8 - 1 3/8 - 1 1/16 - 1 1/16	1 3/4	1 11/32	1 19/32	7.2
2BK90	8.75	8.00	8.40	C	3/4 - 7/8 - 1 - 1 1/8 - 1 3/8 - 1 1/16 - 1 1/16	1 3/4	1 11/32	1 19/32	8.4
2BK100	9.75	9.00	9.40	C	3/4 - 7/8 - 1 - 1 1/8 - 1 3/8 - 1 1/16 - 1 1/16	1 3/4	1 11/32	1 19/32	9.4
2BK110	10.75	10.00	10.40	C	3/4 - 7/8 - 1 - 1 1/8 - 1 3/8 - 1 1/16 - 1 1/16	1 3/4	1 11/32	1 19/32	10.4
2BK120	11.75	11.00	11.40	C	3/4 - 7/8 - 1 - 1 1/8 - 1 3/8 - 1 1/16 - 1 1/16	1 3/4	1 11/32	1 19/32	11.8
2BK130	12.75	12.00	12.40	C	3/4 - 7/8 - 1 - 1 1/8 - 1 3/8 - 1 1/16 - 1 1/16	1 3/4	1 11/32	1 19/32	14.9
2BK140	13.75	13.00	13.40	C	3/4 - 7/8 - 1 - 1 1/8 - 1 3/8 - 1 1/16 - 1 1/16	1 3/4	1 11/32	1 19/32	16.3
2BK160	15.75	15.00	15.40	C	3/4 - 7/8 - 1 - 1 1/8 - 1 3/8 - 1 1/16 - 1 1/16	1 3/4	1 11/32	1 19/32	18.0
2BK190	18.75	18.00	18.40	C	3/4 - 7/8 - 1 - 1 1/8 - 1 3/8 - 1 1/16 - 1 1/16	1 3/4	1 11/32	1 19/32	23.3

1/2" Bore - setscrew only - no keyway

BK-H Single Groove FHP Sheaves

MST® Bushed



TYPE A
Solid

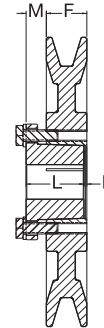

TYPE B
Web

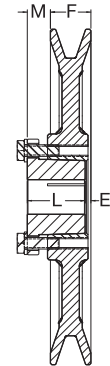

TYPE C
Arm / Spoke

Dimensions in inches, weight in pounds

Part Number	Diameter			Type	Bush	Bush Max. Bore	F	E	L Thru Bore	M	Weight Less Bush
	OD	Datum A(4L) Belts	Datum B(5L) Belts								
BK30-H	3.15	2.40	2.80	A	H	1-1/2	7/8	1/2	1-1/4	7/8	1.3
BK32-H	3.35	2.60	3.00	A	H	1-1/2	7/8	1/2	1-1/4	7/8	1.5
BK34-H	3.55	2.80	3.20	A	H	1-1/2	7/8	1/2	1-1/4	7/8	1.7
BK36-H	3.75	3.00	3.40	B	H	1-1/2	7/8	1/16	1-1/4	7/16	1.3
BK40-H	3.95	3.20	3.60	B	H	1-1/2	7/8	1/16	1-1/4	7/16	1.5
BK45-H	4.25	3.50	3.90	B	H	1-1/2	7/8	1/16	1-1/4	7/16	1.9
BK47-H	4.45	3.70	4.10	B	H	1-1/2	7/8	1/16	1-1/4	7/16	2.2
BK50-H	4.75	4.00	4.40	B	H	1-1/2	7/8	1/16	1-1/4	7/16	2.2
BK52-H	4.95	4.20	4.60	B	H	1-1/2	7/8	1/16	1-1/4	7/16	2.5
BK55-H	5.25	4.50	4.90	B	H	1-1/2	7/8	1/16	1-1/4	7/16	3.0
BK57-H	5.45	4.70	5.10	B	H	1-1/2	7/8	1/16	1-1/4	7/16	3.2
BK60-H	5.75	5.00	5.40	B	H	1-1/2	7/8	1/16	1-1/4	7/16	3.2
BK62-H	5.95	5.20	5.60	B	H	1-1/2	7/8	1/16	1-1/4	7/16	3.6
BK65-H	6.25	5.50	5.90	B	H	1-1/2	7/8	1/16	1-1/4	7/16	4.0
BK67-H	6.45	5.70	6.10	B	H	1-1/2	7/8	1/16	1-1/4	7/16	4.2
BK70-H	6.75	6.00	6.40	C	H	1-1/2	7/8	1/8	1-1/4	1/2	3.3
BK72-H	6.95	6.20	6.60	C	H	1-1/2	7/8	1/8	1-1/4	1/2	3.6
BK75-H	7.25	6.50	6.90	C	H	1-1/2	7/8	1/8	1-1/4	1/2	3.4
BK77-H	7.45	6.70	7.10	C	H	1-1/2	7/8	1/8	1-1/4	1/2	3.7
BK80-H	7.75	7.00	7.40	C	H	1-1/2	7/8	1/8	1-1/4	1/2	4.0
BK85-H	8.25	7.50	7.90	C	H	1-1/2	7/8	1/8	1-1/4	1/2	4.1
BK90-H	8.75	8.00	8.40	C	H	1-1/2	7/8	1/8	1-1/4	1/2	4.5
BK95-H	9.25	8.50	8.90	C	H	1-1/2	7/8	1/8	1-1/4	1/2	4.8
BK100-H	9.75	9.00	9.40	C	H	1-1/2	7/8	1/8	1-1/4	1/2	5.1
BK105-H	10.25	9.50	9.90	C	H	1-1/2	7/8	1/8	1-1/4	1/2	5.4
BK110-H	10.75	10.00	10.40	C	H	1-1/2	7/8	1/8	1-1/4	1/2	6.0
BK115-H	11.25	10.50	10.90	C	H	1-1/2	7/8	1/8	1-1/4	1/2	6.3
BK120-H	11.75	11.00	11.40	C	H	1-1/2	7/8	1/8	1-1/4	1/2	6.6
BK130-H	12.75	12.00	12.40	C	H	1-1/2	7/8	1/8	1-1/4	1/2	7.2
BK140-H	13.75	13.00	13.40	C	H	1-1/2	7/8	1/8	1-1/4	1/2	8.6
BK150-H	14.75	14.00	14.40	C	H	1-1/2	7/8	1/8	1-1/4	1/2	9.4
BK160-H	15.75	15.00	15.40	C	H	1-1/2	7/8	1/8	1-1/4	1/2	10.1
BK190-H	18.75	18.00	18.40	C	H	1-1/2	7/8	1/8	1-1/4	1/2	12.3

Weights do not include bushings.



Two Groove FHP Sheaves MST® Bushed 2BK-H

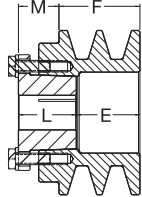

**TYPE A
Solid**

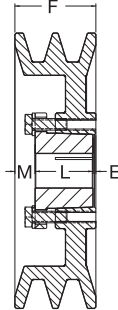

**TYPE B
Web**

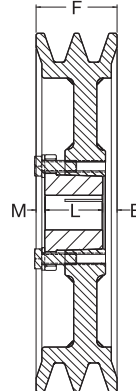

**TYPE C
Arm / Spoke**



Dimensions in inches, weight in pounds

Part Number	Diameter			Type	Bush	Bush Max. Bore	F	E	L Thru Bore	M	Weight Less Bush
	OD	Datum A(4L) Belts	Datum B(5L) Belts								
2BK32-H	3.35	2.60	3.00	A	H	1 1/2	1 3/4	1 3/8	1 1/4	7/8	2.2
2BK34-H	3.55	2.80	3.20	A	H	1 1/2	1 3/4	1 3/8	1 1/4	7/8	2.6
2BK36-H	3.75	3.00	3.40	A	H	1 1/2	1 3/4	15/16	1 1/4	7/16	2.4
2BK40-H	3.95	3.20	3.60	A	H	1 1/2	1 3/4	15/16	1 1/4	7/16	2.6
2BK45-H	4.25	3.50	3.90	A	H	1 1/2	1 3/4	15/16	1 1/4	7/16	3.1
2BK47-H	4.45	3.70	4.10	B	H	1 1/2	1 3/4	1/16	1 1/4	7/16	3.2
2BK50-H	4.75	4.00	4.40	B	H	1 1/2	1 3/4	1/16	1 1/4	7/16	3.7
2BK52-H	4.95	4.20	4.60	B	H	1 1/2	1 3/4	1/16	1 1/4	7/16	4.1
2BK55-H	5.25	4.50	4.90	B	H	1 1/2	1 3/4	1/16	1 1/4	7/16	4.2
2BK57-H	5.45	4.70	5.10	B	H	1 1/2	1 3/4	1/16	1 1/4	7/16	4.5
2BK60-H	5.75	5.00	5.40	B	H	1 1/2	1 3/4	1/16	1 1/4	7/16	4.9
2BK62-H	5.95	5.20	5.60	B	H	1 1/2	1 3/4	1/16	1 1/4	7/16	5.2
2BK65-H	6.25	5.50	5.90	C	H	1 1/2	1 3/4	5/16	1 1/4	3/16	5.7
2BK67-H	6.45	5.70	6.10	C	H	1 1/2	1 3/4	5/16	1 1/4	3/16	5.8
2BK70-H	6.75	6.00	6.40	C	H	1 1/2	1 3/4	5/16	1 1/4	3/16	6.1
2BK72-H	6.95	6.20	6.60	C	H	1 1/2	1 3/4	5/16	1 1/4	3/16	6.1
2BK80-H	7.75	7.00	7.40	C	H	1 1/2	1 3/4	5/16	1 1/4	3/16	7.4
2BK90-H	8.75	8.00	8.40	C	H	1 1/2	1 3/4	5/16	1 1/4	3/16	8.5
2BK100-H	9.75	9.00	9.40	C	H	1 1/2	1 3/4	5/16	1 1/4	3/16	9.7
2BK110-H	10.75	10.00	10.40	C	H	1 1/2	1 3/4	5/16	1 1/4	3/16	10.9
2BK120-H	11.75	11.00	11.40	C	H	1 1/2	1 3/4	5/16	1 1/4	3/16	12.0
2BK130-H	12.75	12.00	12.40	C	H	1 1/2	1 3/4	5/16	1 1/4	3/16	13.4
2BK140-H	13.75	13.00	13.40	C	H	1 1/2	1 3/4	5/16	1 1/4	3/16	15.3
2BK160-H	15.75	15.00	15.40	C	H	1 1/2	1 3/4	5/16	1 1/4	3/16	17.8
2BK190-H	18.75	18.00	18.40	C	H	1 1/2	1 3/4	5/16	1 1/4	3/16	22.8

Weights do not include bushings.

MST "H" Bushings – Inch Bore

Diameter Of Shaft	Keyway Width X Depth	Diameter Of Shaft	Keyway Width X Depth
3/8	NONE	1	1/4 X 1/8
7/16	NONE	1-1/16	1/4 X 1/8
1/2	1/8 X 1/16	1-1/8	1/4 X 1/8
9/16	1/8 X 1/16	1-3/16	1/4 X 1/8
19/32	1/8 X 1/16	1-1/4	1/4 X 1/8
5/8	3/16 X 3/32	1-5/16	5/16 X 1/16
21/32	3/16 X 3/32	1-3/8	5/16 X 1/16
11/16	3/16 X 3/32	1-3/8W	3/8 X 1/16
3/4	3/16 X 3/32	1-7/16	3/8 X 1/16
25/32	3/16 X 3/32	1-1/2	3/8 X 1/32
13/16	3/16 X 3/32		
7/8	3/16 X 3/32		
15/16	1/4 X 1/8		
31/32	1/4 X 1/8		

MST "H" Bushings – Millimeter Bore

Diameter Of Shaft	Keyway Width X Depth	Diameter Of Shaft	Keyway Width X Depth
10	NONE	22	6 X 2.8
11	NONE	24	8 X 3.3
12	NONE	25	8 X 3.3
14	5 X 2.3	28	8 X 3.3
16	5 X 2.3	30	8 X 3.3
18	6 X 2.8	32	10 X 1.3
19	6 X 2.8	35	10 X 0.3
20	6 X 2.8	36	10 X 1.3
		38	10 X 0.3

1VP Single Groove Variable Pitch Sheaves – Bored-To-Size

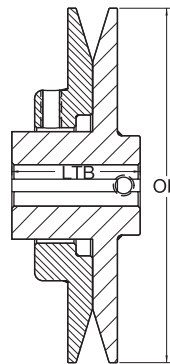

TYPE A

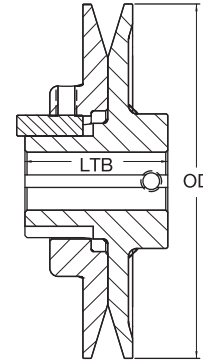

TYPE B

Dimensions in inches

Part Number	Diameters And Turns															
	3L Belts				A or 4L Belts				B or 5L Belts				5V Belts			
	Min. Pitch	Turns Open	Max. Pitch	Turns Open	Min. Datum	Turns Open	Max. Datum	Turns Open	Min. Datum	Turns Open	Max. Datum	Turns Open	Min. Pitch	Turns Open	Max. Pitch	Turns Open
1VP25	1.6	4	2.4	0	-	-	-	-	-	-	-	-	-	-	-	-
1VP30	1.8	4	2.7	0	-	-	-	-	-	-	-	-	-	-	-	-
1VP34	1.9	4	2.8	0	2.0	5	3.0	0	2.3	5	3.2	1	-	-	-	-
1VP40	2.4	4	3.2	0	2.5	5	3.5	0	2.6	6	3.6	1	-	-	-	-
1VP44	2.8	4	3.7	0	2.9	5	3.9	0	3.0	6	4.0	1	-	-	-	-
1VP50	3.4	4	4.2	0	3.5	5	4.5	0	3.6	6	4.6	1	-	-	-	-
1VP56	4.0	4	4.8	0	4.1	5	5.1	0	4.2	6	5.2	1	-	-	-	-
1VP60	-	-	-	-	4.2	5	5.2	0	4.4	6	5.6	0	-	-	-	-
1VP62	4.6	4	5.4	0	4.7	5	5.7	0	4.8	6	5.8	1	5.1	6	6.1	1
1VP65	-	-	-	-	4.7	5	5.7	0	4.9	6	6.1	0	5.1	6	6.3	0
1VP68	5.2	4	6.0	0	5.3	5	6.3	0	5.4	6	6.4	1	5.7	6	6.7	1
1VP71	-	-	-	-	5.3	5	6.3	0	5.5	6	6.7	0	5.7	6	6.9	0
1VP75	-	-	-	-	5.7	5	6.7	0	5.9	6	7.1	0	6.1	6	7.3	0

Dimensions in inches

Part Number	OD	Type	L Thru Bore	Stock Finished Bores Includes Keyway and Setscrew												Wt. Lbs. (Approx.)	
				1/2	5/8	3/4	7/8	1	1-1/8	1-1/4	1-3/8	1-1/2	1-5/8	1-3/4			
1VP25	2.50	A	1-23/32	1/2	-	5/8	-	3/4	-	-	-	-	-	-	-	-	0.8
1VP30	2.87	A	1-11/16	1/2	-	5/8	-	3/4	-	-	-	-	-	-	-	-	1.1
1VP34	3.15	A	1-29/32	1/2	-	5/8	-	3/4	-	7/8	-	-	-	-	-	-	1.4
1VP40	3.75	A	1-7/8	1/2	-	5/8	-	3/4	-	7/8	-	-	-	-	-	-	1.7
1VP44	4.15	A	1-7/8	1/2	-	5/8	-	3/4	-	-	-	-	-	-	-	-	2.4
1VP44	4.15	B	2-3/16	-	-	-	-	-	7/8	-	1	-	1-1/8	-	-	-	3.0
1VP50	4.75	A	2	1/2	-	5/8	-	3/4	-	-	-	-	-	-	-	-	2.7
1VP50	4.75	B	2-5/32	-	-	-	-	-	7/8	-	1	-	1-1/8	-	-	-	3.5
1VP56	5.35	A	1-15/16	1/2	-	5/8	-	3/4	-	-	-	-	-	-	-	-	4.1
1VP56	5.35	B	2-5/32	-	-	-	-	-	7/8	-	1	-	1-1/8	-	-	-	4.4
1VP60	6.00	B	2-7/32	-	5/8	-	3/4	-	7/8	-	1	-	1-1/8	-	-	1-3/8	6.3
1VP62	5.95	B	1-29/32	-	5/8	-	3/4	-	7/8	-	1	-	1-1/8	-	1-1/4	1-3/8	6.1
1VP65	6.50	B	2-7/32	-	-	-	3/4	-	7/8	-	-	-	1-1/8	-	-	1-3/8	7.1
1VP68	6.55	B	1-29/32	-	5/8	-	3/4	-	7/8	-	1	-	1-1/8	-	1-1/4	1-3/8	7.3
1VP71	7.10	B	2-7/32	-	-	-	3/4	-	7/8	-	-	-	1-1/8	-	-	1-3/8	8.2
1VP75	7.50	B	2-7/32	-	-	-	3/4	-	7/8	-	1	-	1-1/8	-	-	1-3/8	9.0

1/2" Bore - setscrew only - no keyway



Two Groove Variable Pitch Sheaves – Bored-To-Size 2VP

Keyway Dimensions Inch Bore

Diameter Of Shaft	Keyway Width X Depth
1/2	NONE
5/8 - 7/8	3/16 X 3/32
15/16 - 1-1/4	1/4 X 1/8
1-5/16 - 1-3/8	5/16 X 5/32
1-7/16 - 1-3/4	3/8 X 3/16

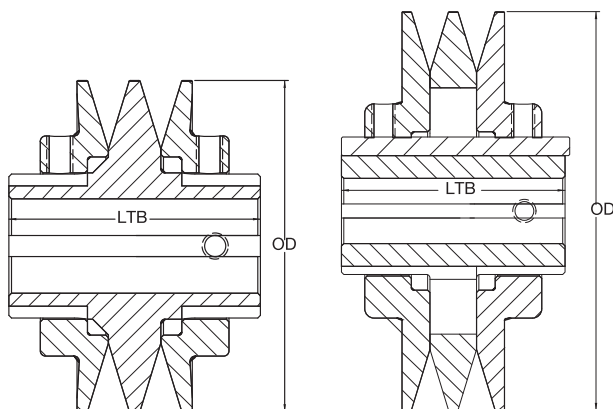

TYPE A

TYPE B



Dimensions in inches

Part Number	Diameters And Turns															
	3L Belts				A or 4L Belts				B or 5L Belts				5V Belts			
	Min. Pitch	Turns Open	Max. Pitch	Turns Open	Min. Datum	Turns Open	Max. Datum	Turns Open	Min. Datum	Turns Open	Max. Datum	Turns Open	Min. Pitch	Turns Open	Max. Pitch	Turns Open
2VP36	2.0	4	2.8	0	2.1	5	3.1	0	2.4	5	3.2	1	-	-	-	-
2VP42	2.6	4	3.4	0	2.7	5	3.7	0	2.8	6	3.8	1	-	-	-	-
2VP50	3.4	4	4.2	0	3.5	5	4.5	0	3.6	6	4.6	1	-	-	-	-
2VP56	4.0	4	4.8	0	4.1	5	5.1	0	4.2	6	5.2	1	-	-	-	-
2VP60	-	-	-	-	4.2	5	5.2	0	4.4	6	5.6	0	-	-	-	-
2VP62	4.6	4	5.4	0	4.7	5	5.7	0	4.8	6	5.8	1	5.1	6	6.1	1
2VP65	-	-	-	-	4.7	5	5.7	0	4.9	6	6.1	0	5.1	6	6.3	0
2VP68	5.2	4	6.0	0	5.3	5	6.3	0	5.4	6	6.4	1	5.7	6	6.7	1
2VP71	-	-	-	-	5.3	5	6.3	0	5.5	6	6.7	0	5.7	6	6.9	0
2VP75	-	-	-	-	5.7	5	6.7	0	5.9	6	7.1	0	6.1	6	7.3	0

Dimensions in inches

Part Number	OD	Type	L Thru Bore	Stock Finished Bores Includes Keyway and Setscrew												Wt. Lbs. (Approx.)	
				1/2	5/8	3/4	7/8	1	1-1/8	1-1/4	1-3/8	1-1/2	1-5/8	1-3/4			
2VP36	3.35	A	3	-	-	-	-	-	-	-	-	-	-	-	-	-	3.6
2VP42	3.95	A	3	-	-	-	-	-	-	-	-	-	-	-	-	-	4.5
2VP50	4.75	B	3	-	-	-	-	-	-	-	-	-	-	-	-	-	6.1
2VP56	5.35	B	3	-	-	-	-	-	-	-	-	-	-	-	-	-	7.5
2VP60	6.00	B	3-1/4	-	-	-	-	-	-	-	-	-	-	-	-	-	10.9
2VP62	5.95	B	3	-	-	-	-	-	-	-	-	-	-	-	-	-	10.0
2VP65	6.50	B	3-1/4	-	-	-	-	-	-	-	-	-	-	-	-	-	12.5
2VP68	6.55	B	3	-	-	-	-	-	-	-	-	-	-	-	-	-	11.7
2VP71	7.10	B	3-1/4	-	-	-	-	-	-	-	-	-	-	-	-	-	14.7
2VP75	7.50	B	3-1/4	-	-	-	-	-	-	-	-	-	-	-	-	-	16.3

1/2" Bore - setscrew only - no keyway



INVENTORY: *Martin* delivers with incredible fill rates from one of its many facilities strategically located across North America.

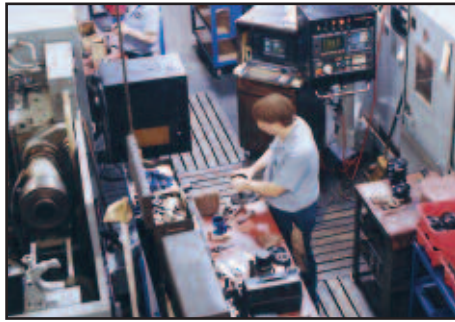

SERVICE: *Martin* ships rebores and other alterations within hours - not days... MTO's in days - not weeks.



PEOPLE: When you call *Martin* you get a person, not voice mail. We are ready, able and willing to help...Now!

USA

General Offices Sales and Manufacturing

Arlington, TX

3100 Sprocket Drive 76015-2898
P.O. Box 91588
Arlington, Texas 76015-0088
817-258-3000 (FAX 817-258-3333)

Sales and Manufacturing

Danielsville, PA

3376 Delps Road 18038
P.O. Box 267 • Danielsville, PA 18038-0267
610-837-1841 (FAX 610-837-7337)

Ft. Worth, TX

(Conveyor & Tool Divisions)
3600 McCart Ave.
Ft. Worth, TX 76110-4692
817-258-3000 (FAX 817-258-3173)

Montpelier, OH

350 S. Airport Road
Montpelier, OH 43543-9329
419-485-5515 (FAX 419-485-3565)

Sacramento, CA

1199 Vine Street
Sacramento, CA 95814-0426
916-441-7172 (FAX 916-441-4600)

Scottdale, GA

3303 Church Street 30079-1395
P.O. Box 886 • Scottdale, GA 30079-0886
404-292-8744 (FAX 404-292-7771)

Mini Manufacturing Centers

Boston, MA

357 Fortune Boulevard
Milford, MA 01757
508-634-3990 (FAX 508-634-3998)

Charlotte, NC

3901 Scott Futrell Drive
Charlotte, NC 28208-3539
704-394-9111 (FAX 704-394-9122)

Chicago, IL

1505 Birchwood Avenue
Des Plaines, IL 60018-3001
847-298-8844 (FAX 847-298-2967)

Denver, CO

10800 East 54th Avenue
Denver CO 80239
303-371-8466 (FAX 303-371-7116)

Detroit, MI

12555 Belden Ct.
Livonia, MI 48150
734-367-0238 (FAX 734-367-0547)

Houston, TX

9910 Bent Oak Drive
Houston, TX 77040
713-849-4330 (FAX 713-849-4807)

Kansas City, MO

1520 N. Commerce Avenue
Kansas City, MO 64120-4961
816-231-5575 (FAX 816-231-1959)

Los Angeles, CA

5920 S. Triangle Drive
Commerce, CA 90040-3639
323-728-8117 (FAX 323-722-7526)

Minneapolis, MN

10601 Hampshire Avenue South
Bloomington, MN 55438-2395
952-829-0623 (FAX 952-944-9385)

Portland, OR

3030 N.W. Industrial
Portland, OR 97210-1734
503-223-7261 (FAX 503-221-0203)

Tampa, FL

3201 Queen Palm Drive
Tampa FL 33619
813-623-1705 (FAX 813-626-8953)

Wayne, NJ

7 High Point Drive
Wayne, NJ 07470-7432
973-633-5700 (FAX 973-633-7196)

Manufacturing Only

Abilene, TX

Clarksville, TX

Dallas, TX

Mansfield, TX

Paragould, AR (Includes the Plastics Div.)

CANADA

Sales and Manufacturing

Martin Sprocket & Gear Canada Inc.

896 Meyerside Drive
Mississauga, Ontario, Canada L5T 1R9
905-670-1991 (FAX 905-670-2110)

Martin Sprocket & Gear Canada Inc.

(Conveyor Division)
1030 Industrial Road
Ayr, Ontario, Canada NOB 1E0
519-621-0546 (FAX 519-621-4413)

MEXICO

Sales and Manufacturing

Martin Sprocket & Gear de Mexico, S.A. de C.V.

Km 52 Carretera, Naucalpan-Toluca
Calle 3, Manzana VII, Lote 11
Parque Industrial Toluca 2000
Toluca, Edo. de México 50200
+52 722 276 0800 (Fax: +52 722 276 0801)

"Where dependability is a tradition...and exceptional service is nothing new!"

***Martin* SPROCKET & GEAR, INC.** • 3100 SPROCKET DR. • ARLINGTON, TX 76015 • 817-258-3000

For more information, contact your nearest *Martin* Distributor or Service Center.